



# PUMA V series

## PUMA V400/V550

High Performance Vertical Turning Center



Doosan Machine Tools

*Optimal Solutions for the Future*

# PUMA V series

## PUMA V400/V550

The vertical turning center is designed for long term accuracy, heavy duty cutting and to minimize floor space. Its powerful spindle drives, meehanite casting and integral box guide way provide unsurpassed rigidity.



# New Standard for Unsurpassed High Productivity, High Speed and High Precision



# PUMA V400 series

## Main Spindle

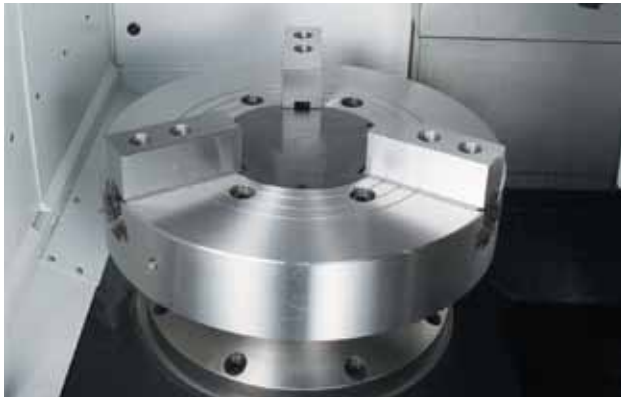

The cartridge type spindle with A2#8 spindle nose assures high capability and easy of maintenance. Especially rigid coupled bearing assembly is to support heavy weight workpiece and reduces thermal growth in long run operation.

Max. spindle speed      Motor (30 min)  
**3000 r/min      22 kW (29.5 Hp)**

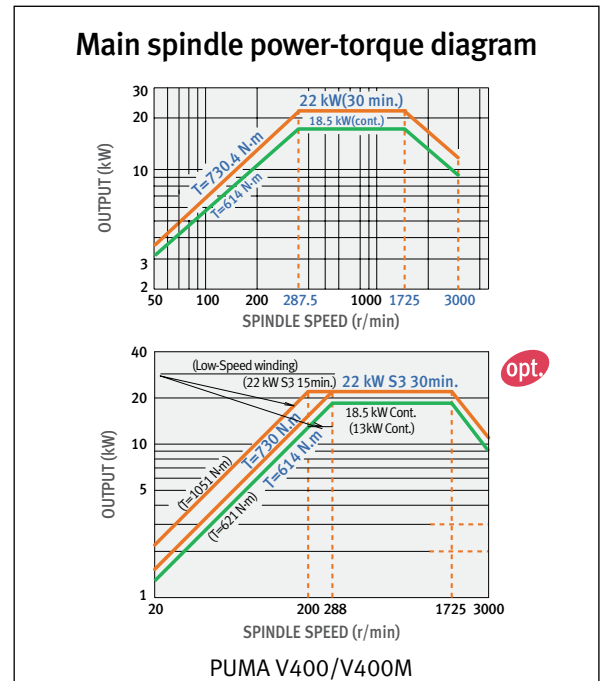

## Rigidity Bed and Wide Working Range



X-axis travel  
**268 mm**  
 (10.55 inch)

Z-axis travel  
**488 mm**  
 (19.21 inch)

Meehanite cast iron bed and integral box guideways provide the rigid foundation needed for superior precision, deep cutting and rugged dependability. The heavily-ribbed and exclusive bed design provides unsurpassed rigidity, enabling heavy cutting and assuring stability for exceptional accuracy and superior

## Machining range

A : Max. turning diameter

**496 (420) mm**  
 (19.53 (16.54) inch)

B : Max. turning length

**461 (400) mm**  
 (18.15 (15.75) inch)

( ) : on PUMA V400M



## Rapid Traverse



X-axis  
**20 m/min**  
 (787.4 ipm)

Z-axis  
**20 m/min**  
 (787.4 ipm)

## BMT Turret (PUMA V400M)



Index time (1-station swivel)

**0.15 s**

No. of tool station

**12 (12+12)<sup>\*1</sup> stations**  
**8 (8+8)<sup>\*1</sup> stations (opt)**

\*1 : PUMA V400-2SP

The large 12 station heavy duty turret features a large diameter Curvic coupling and heavy duty design with unsurpassed rigidity. Turret rotation, acceleration and deceleration are all controlled by a reliable high torque servo motor. Unclamp and rotation are virtually simultaneous. Its fast index response reduces the total cycle time

### Rotary tool spindle power-torque diagram

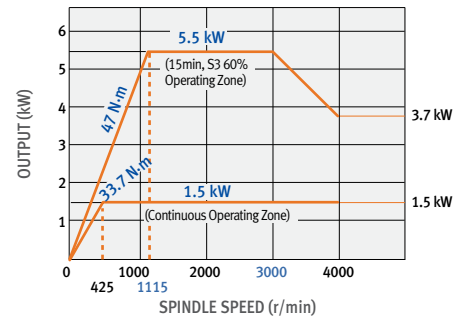

PUMA V400M BMT65P rotary spindle

### PUMA V400M Radial BMT Turret



PUMA V400M : BMT65P

## Rotary Tool Head

The new rotary tool head confirms the high rigidity and accuracy by simultaneous dual contact between the rotary tool head face and tool holding insert (called Preci-flex adapter) flange face as well as tool head pocket taper

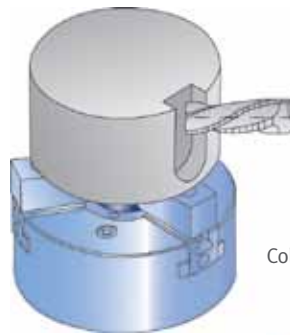

Preci-flex adapter application



Collet application



## Double-Paneled Safety Window

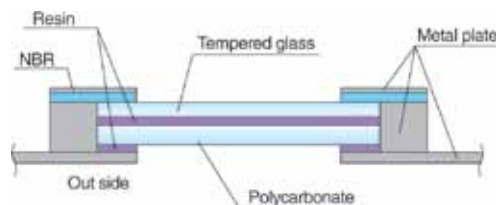
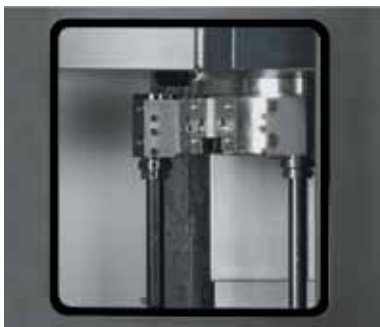

The operator safety can be enhanced through the front door with its shock absorbing laminated glass and double panel construction. The windows without grating also provide a clear view of the machine inside.

# PUMA V550 series

## Main Spindle

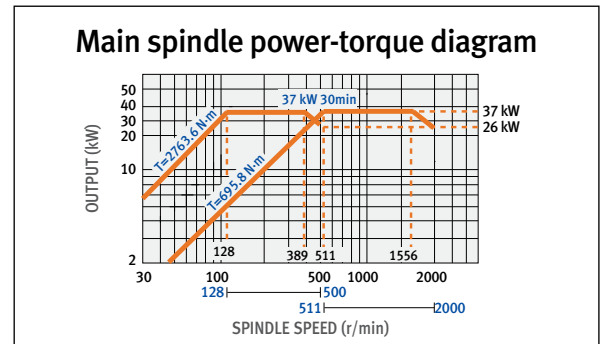
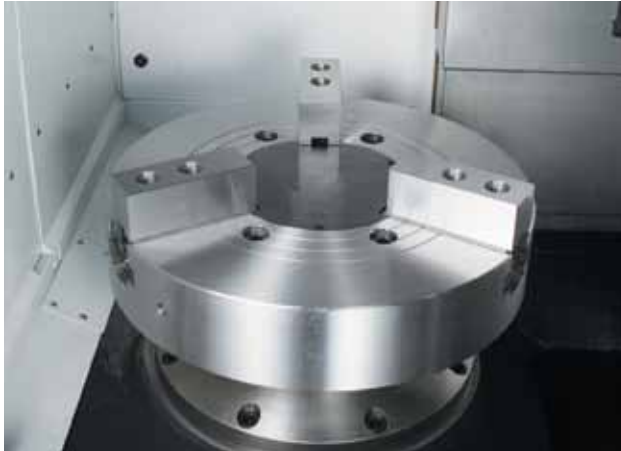

Max. spindle speed      Motor (30 min)

**2000 r/min    37 kW (49.6 Hp)**

The cartridge-type precision spindle is assembled in a temperature controlled clean room. Four rows of high precision roller bearings and two rows of angular contact thrust bearings support the A2#11 American standard type spindle nose. The entire assembly is per-manently grease lubricated, which eliminates routine maintenance and reduces thermal growth. Twin spindle model(PUMA V550-2SP) have an independent direct drive system for each spindle. This permits either synchronous or asynchronous operation to double your productivity, or to machine complete components from each unit.

## Rigidity Bed and Wide Working Range

X-axis travel

**390 (490)\*1 mm**  
(15.35 (19.29) inch)

Z-axis travel

**780 mm**  
(30.71 inch)

\*1 : PUMAV550M



The one piece bed and box type column castings are rigid and heavily ribbed. Meehanite cast iron. These castings remain stable even under the heaviest cutting conditions. Fine grained Meehanite cast iron is used for its excellent vibration absorbing characteristics. The cross slide body is fully supported by the saddle in all positions and there is no table overhang.

Workpiece space and interference space

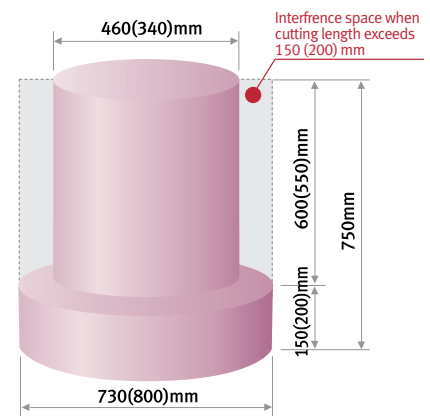

( ) : PUMA V550M

## Rapid Traverse



X-axis

**20 m/min (787.4 ipm)**

\* only PUMA V550M : 12 m/min (472.4 ipm)

Z-axis

**16 m/min (629.9 ipm)**

## BMT Turret (PUMA V550M)



Index time  
(1-station swivel)

**0.15 s**

No. of tool station

**8 (8+8)<sup>\*1</sup>  
stations**

<sup>\*1</sup> : PUMA V550-2SP : 8+8

The large 8 station heavy duty turret features a large diameter Curvic coupling and heavy duty design with unsurpassed rigidity. Turret rotation, acceleration and deceleration are all controlled by a reliable high torque servo motor. Unclamp and rotation are virtually simultaneous. Its fast index response reduces the total cycle time required to machine parts.

### Rotary tool spindle power-torque diagram

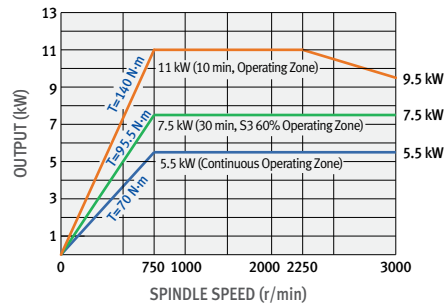

PUMA V550M BMT75P rotary spindle

### PUMA V550M Radial BMT Turret



The turret features BMT75P style tooling in which the toolholders are mounted directly to the turret's periphery using 4 large bolts. This type of mounting system allows an extremely high degree of rigidity.

Index time (1-station swivel)

**0.25 s**

No. of tool station

**12 stations**

## Preci-Flex Ready Rotary Tools

Preci-Flex ready rotary tool holders are available on the milling versions. Preci-Flex is a tooling system that utilizes the existing ER collet taper in the rotary holders. The spindle face is precision ground relative to the taper and there are four drilled and tapped holders in this face. The Preci-Flex adapters locate on both the taper and the spindle face for maximum rigidity.

Preci-flex adapter application

Collet application



## Double-Paneled Safety Window

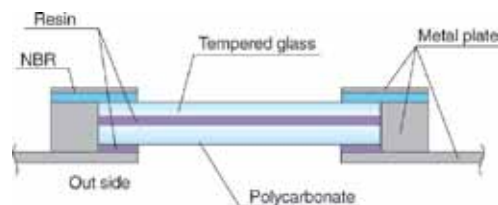

The operator safety can be enhanced through the front door with its shock absorbing laminated glass and double panel construction. The windows without grating also provide a clear view of the machine inside.

# Tooling System

Unit: mm (inch)

## PUMA V400/V400-2SP

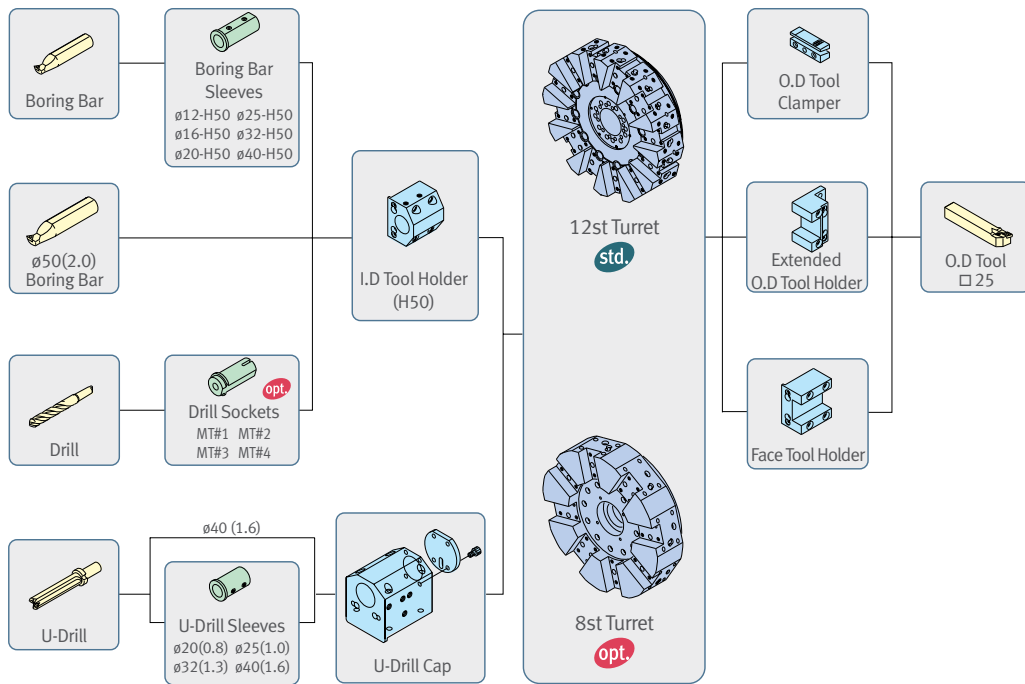

## PUMA V400M

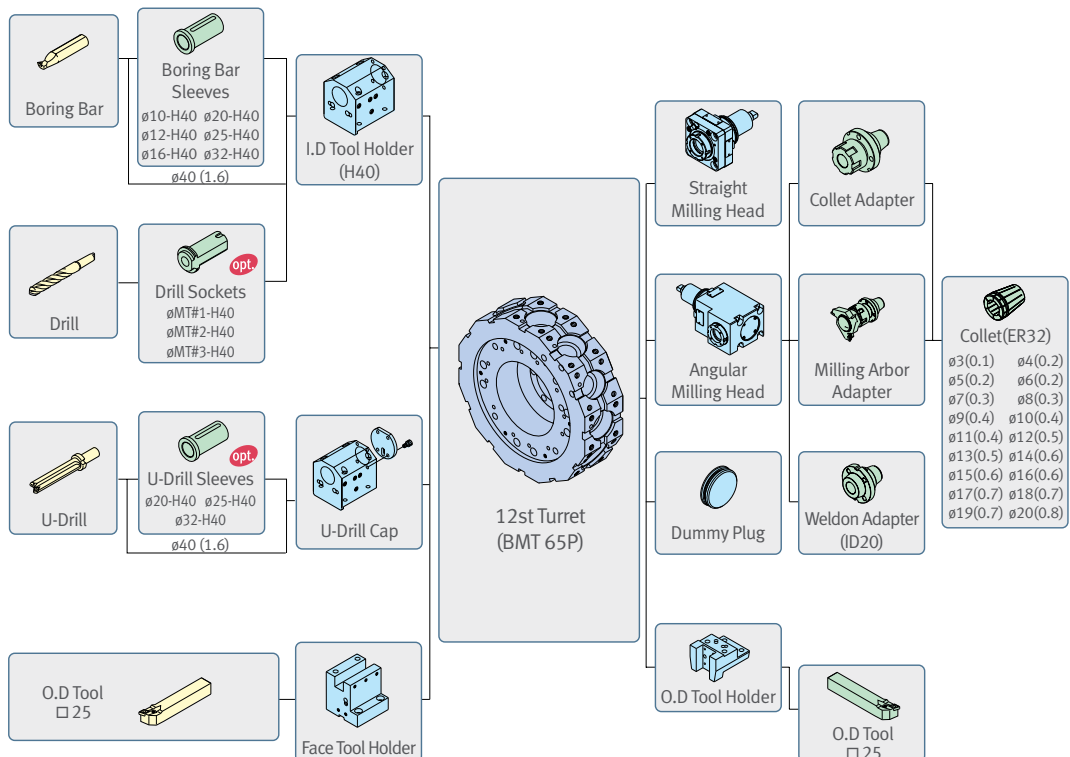



## PUMA V550/V550-2SP

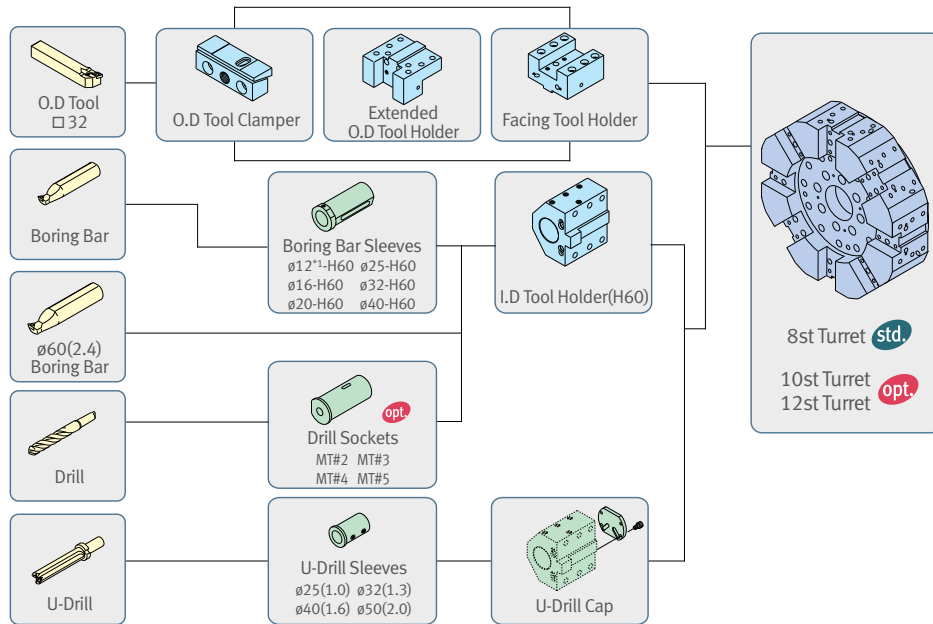

## PUMA V550M

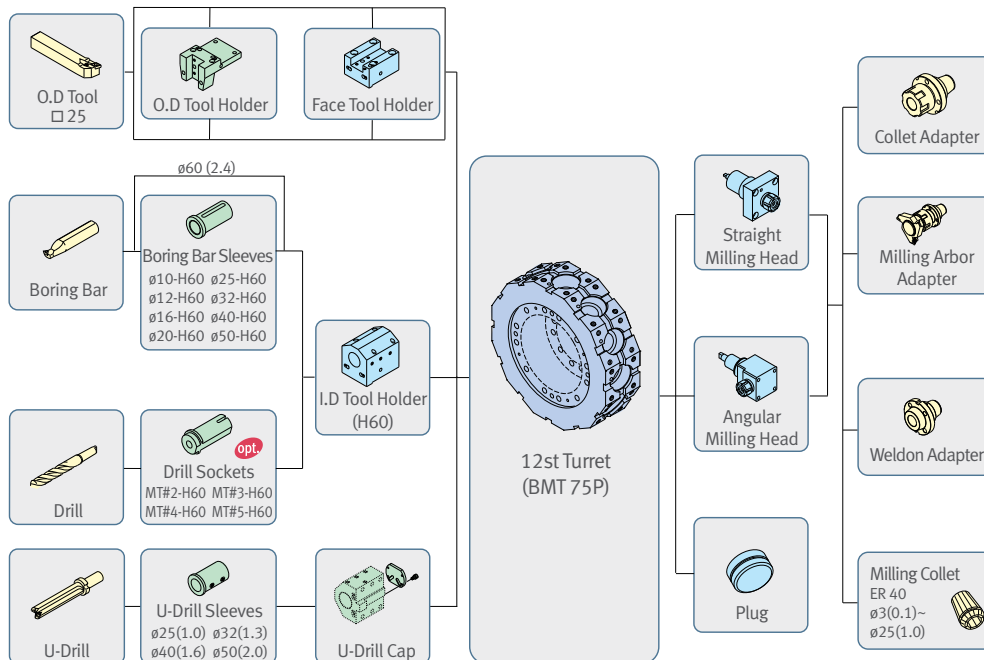

Note) Above tooling system is our recommendation.  
 Depending on export condition, the standard tooling packed with the machine can be different.

# Tool Interference Diagram

Unit: mm (inch)

## PUMA V400/V400-2SP

(1) PUMA V400 : 12 stations

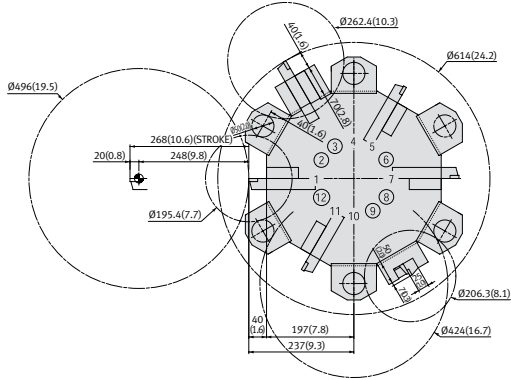

(2) PUMA V400 : 8 stations **opt.**

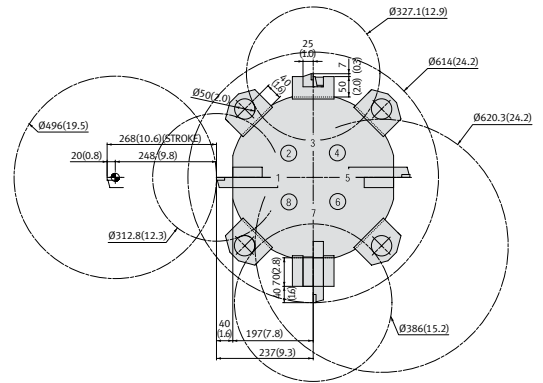

## PUMA V400M

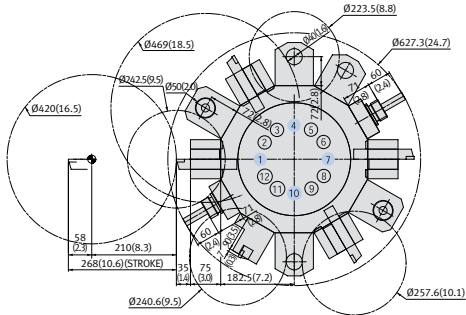

## PUMA V550M

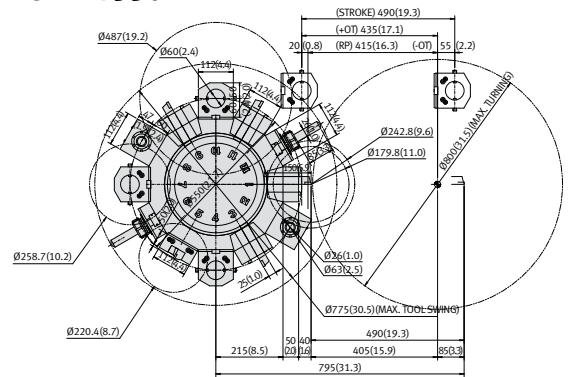

## PUMA V550/V550-2SP

(1) PUMA V550 : 8 stations

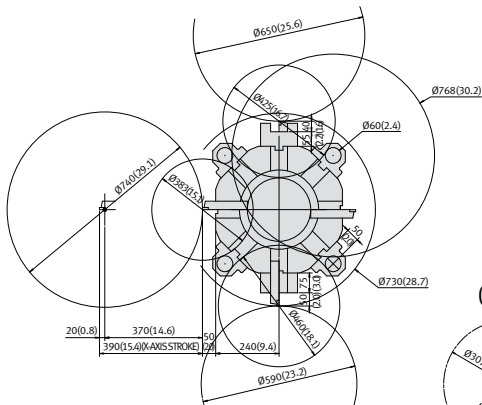

(2) PUMA V550 : 10 stations **opt.**

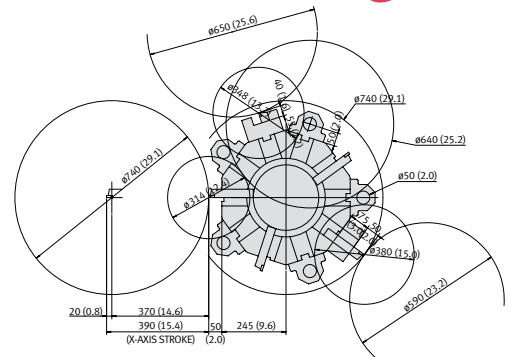

(3) PUMA V550 : 12 stations **opt.**

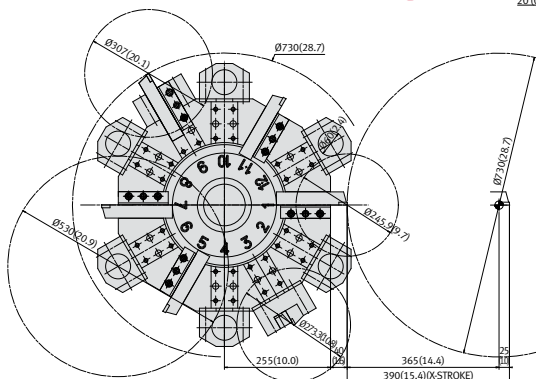

# Working Ranges

Unit: mm (inch)

## PUMA V400/V400-2SP

OD tool holder range

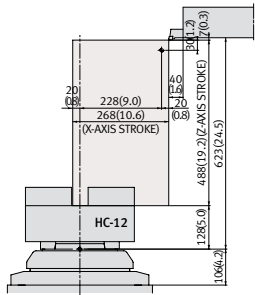

Extended OD tool holder range

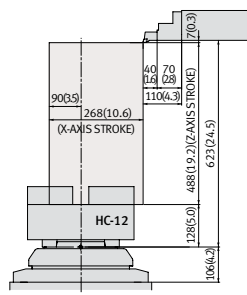

ID tool holder range

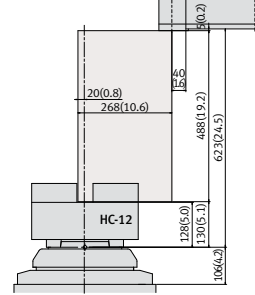

## PUMA V400M

OD tool holder range

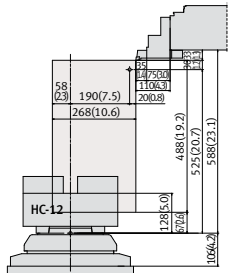

ID tool holder range

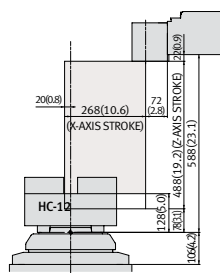

Straight milling unit

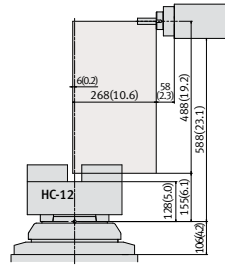

Angular milling head

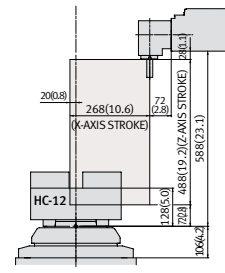

## PUMA V550/V550-2SP

OD tool holder range

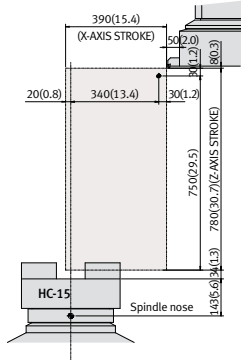

Extended OD tool holder range

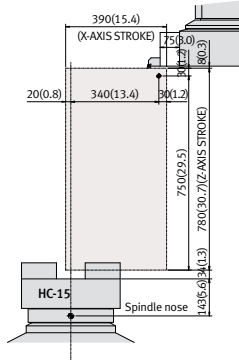

ID tool holder range

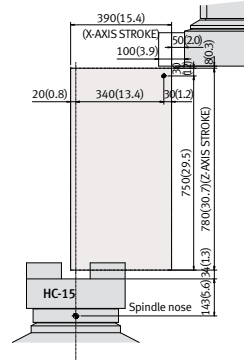

## PUMA V550M

OD tool holder range

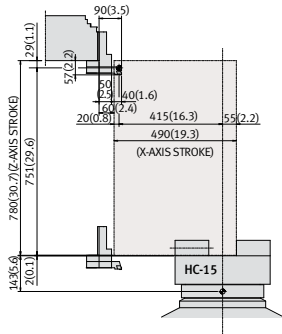

ID tool holder range

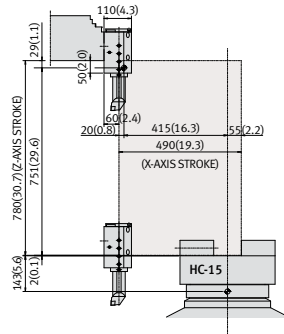

Straight milling unit

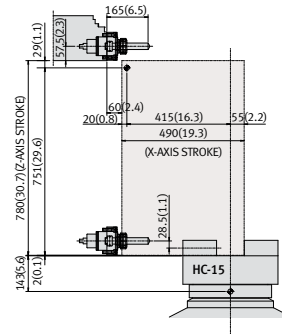

Angular milling head

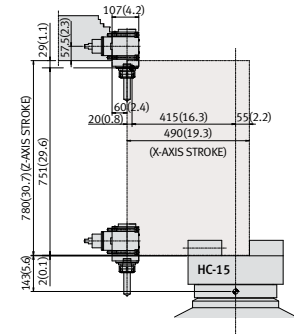

# External Dimension

Unit: mm (inch)

## PUMA V400/M

Top view

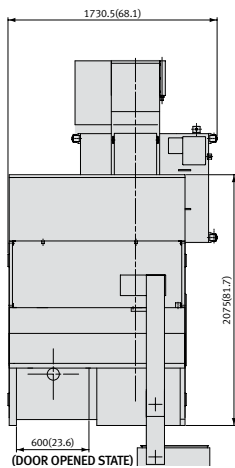

Front view

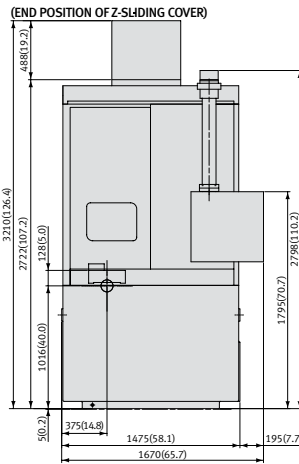

Side view

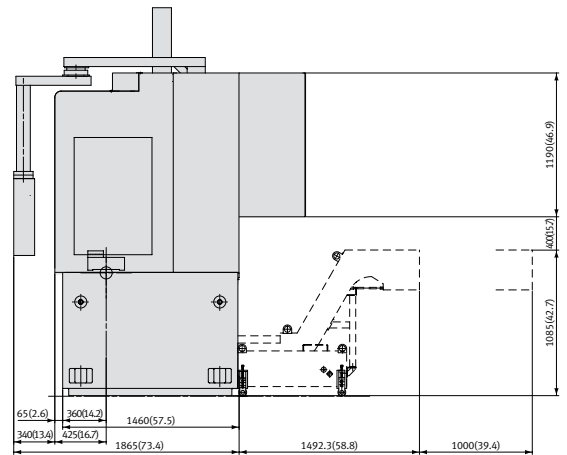

Note) Right Handed Model of PUMA V400 series

## PUMA V400-2SP

Top view

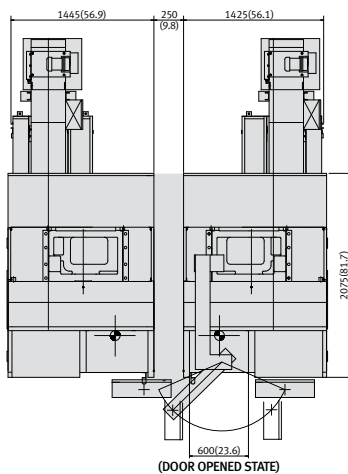

Front view

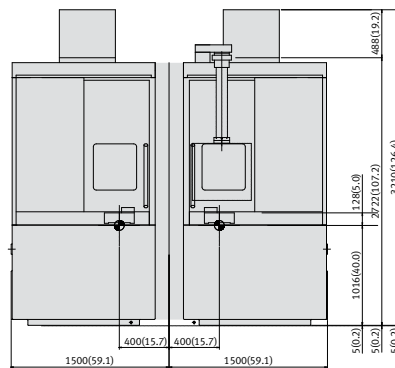

Side view

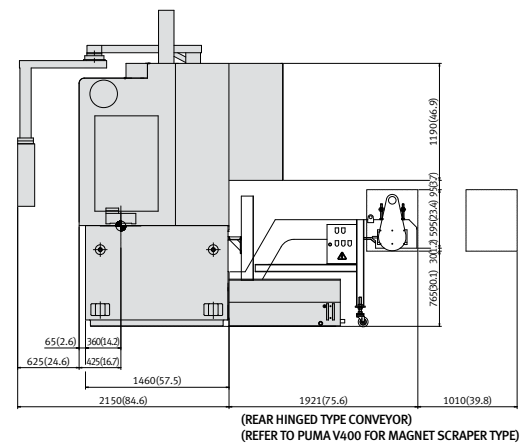

## PUMA V550M

Top view

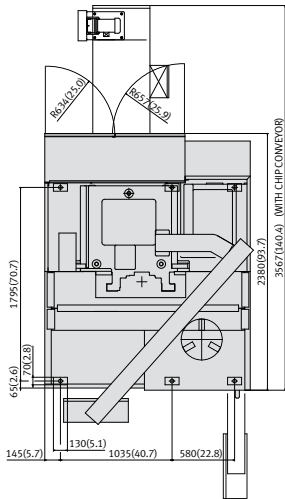

Front view

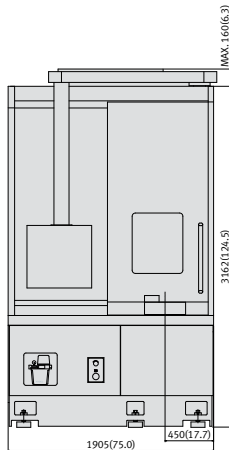

Side view

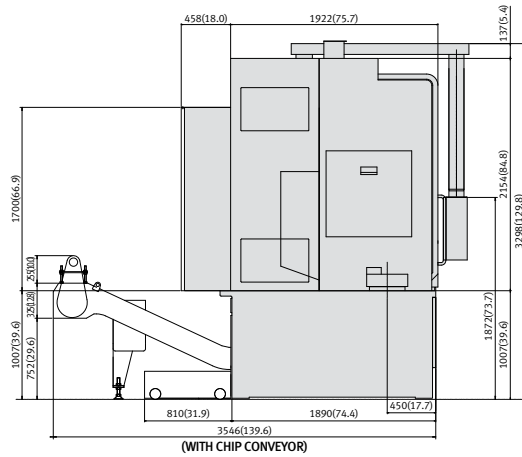

Note) Left Handed Model of PUMA V550 series

## PUMA V550/V550-2SP

Top view

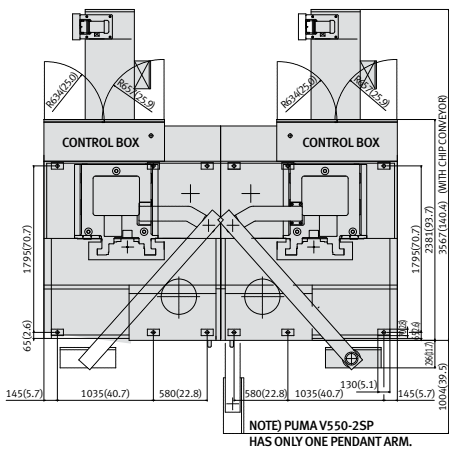

Front view

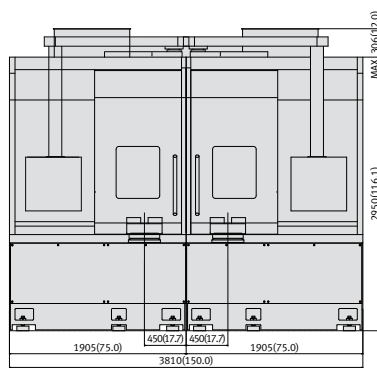

Side view

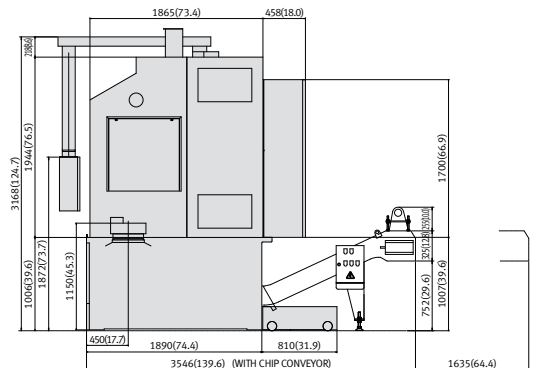

# Machine Specifications

Description		Unit	PUMA V400	PUMA V400M	PUMA V400-2SP	PUMA V550	PUMA V550M	PUMA V550-2SP
Capacity	Swing over bed	mm (inch)	610 (24.0)			800 (31.5)		
	Swing over saddle	mm (inch)	500 (19.7)			490 (19.3)		
	Recom. turning diameter	mm (inch)	305 (12.0)			550 (21.7)		
	Max. turning diameter	mm (inch)	496 (19.5)	420 (16.5)	496 (19.5)	730 (28.7)	800 (31.5)	730 (28.7)
	Max. turning length	mm (inch)	461 (18.1)	400 (15.7)	461 (18.1)	750 (29.5)		
Travels	Travel distance	X-axis travel	268 (10.6)			390 (15.4)	490 (19.3)	390 (15.4)
		Z-axis travel	488 (19.2)			780 (30.7)		
	Chuck size	mm (inch)	305(12")			380(15")		
Feedrates	Rapid traverse	X-axis	20			20	12	20
		Z-axis	20			16		
Main Spindle	Spindle speed	r/min	3000			2000		
	Spindle nose	ASA	A2#8			A2#11		
	Spindle bearing diameter (Front)	mm (inch)	130 (5.1)			160 (6.3)		
	Spindle through hole	mm (inch)	90 (3.5)			140 (5.5)		
	Main spindle indexing angle (C-axis)	deg	-	360 (0.001)	-	-	360 (0.001)	-
Turret	No. of tool stations	station	12 {8}	12	12+12 {8+8}	8 {10, 12}	12	8+8 {10+10, 12+12}
	OD tool size	mm (inch)	25 (1.0)			32 (1.3)	25 (1.0)	32 (1.3)
	Max. boring bar size	mm (inch)	50 (2.0)	40 (1.6)	50 (2.0)	60 (2.4)		
	Turret Indexing time (1 station swivel)	s	0.15			0.15	0.25	0.15
	Rotary tool spindle speed	r/min	-	4000	-	-	3000	-
Motor	Main spindle motor power (30min)	kW	22			37		
	Rotary tool spindle motor	kW	-	5.5	-	-	11	-
Power Source	Electric power supply	kVA	40.3	44.7	81	54.4	56.6	103.9
Machine Dimensions	Height	mm (inch)	3210 (126.4)			3260 (128.3)	3390 (133.5)	3260 (128.3)
	Length	mm (inch)	1455 (57.3)		2910 (114.6)	1905 (75.0)		3810 (150.0)
	Width	mm (inch)	2075 (81.7)			2720 (107.1)		
	Weight	kg	6000		12000	9000	9100	18000

{ } : Option

## Standard Feature

- Coolant supply equipment
- Controller : Doosan Fanuc i series<sup>\*1</sup>
- Controller : Fanuc 31i<sup>\*2</sup>
- Full enclosure chip and coolant shield
- Hand tool kit, including small hand tool for operations
- Hydraulic chuck & actuating cylinder
- Hydraulic power unit
- Leveling jack screw & plates
- Lubrication equipment
- Soft jaws (total)
- Standard tooling kit (tool holders & boring sleeve)
- Work light

## Optional Feature

- Air blast for chuck jaw cleaning
- Automatic door
- Automatic door with safety device
- Chip conveyor & Chip bucket
- Controller : Fanuc 32i<sup>\*1</sup>
- Coolant flushing
- Dual chucking pressure
- Hardened & ground jaws
- Manual tool presetter
- Oil skimmer
- Signal tower (yellow, red, green)
- Proximity switch for chuck clamp detection
- Special chucks

\* Design and specifications are subject to change without prior notice.  
 • Doosan is not responsible for difference between the information in the catalogue and the actual machine.

\*1 : PUMA V400/400M/V550/V550M \*2 : PUMA V400-2SP, V550-2SP

• The specifications and information above-mentioned may be changed without prior notice.  
 • For more details, please contact Doosan

# NC Unit Specifications

	Description	Spec.	Doosan Fanuc i series	Fanuc 32i	Fanuc 31i
Controls	Controlled axes		X, Z, C (!)	X, Z, C (!)	X1, Z1, X2, Z2
	Simultaneously controlled axes	Std. 2 axes	4 axes (!)	3 axes (!)	4 axes
Axis Functions	Backlash compensation	0~±9999 pulses	○	○	○
	Cs contouring control		○ (!)	○ (!)	-
	Follow-up / Chamfering on/off		○	○	○
	HRV2 control		○	○	○
	Least input increment	0.001mm / 0.0001"	○	○	○
	Stored stroke check1	Overtravel control	○	○	○
Operation	Automatic operation(memory) / Buffer register		○	○	○
	Handle incremental feed	X1, X10, X100	○	○	○
Interpolation	Search function	Sequence NO. / Program NO.	○	○	○
	1st, reference position return	Manual, G28	○	○	○
	2nd reference position return	G30	○	○	○
	Reference position return check	G27	○	○	○
	Circular interpolation	G02, G03	○	○	○
	Continuous thread cutting		○	○	○
	Dwell	G04	○	○	○
	Linear interpolation	G01	○	○	○
	Multiple threading / Thread cutting retract		○	○	○
	Polar coordinate interpolation		○ (!)	○ (!)	-
Feed Functions	Thread cutting / Synchronous cutting		○	○	○
	Feed per minute / Feed per revolution		○	○	○
	Feedrate override	0 - 200 % (10 % unit)	○	○	○
	Jog feed override	0 - 2000 mm/min	○	○	○
	Rapid traverse override	F0 / 25 / 100 %	○	○	○
Auxiliary & Spindle Functions	Tangential speed constant control		○	○	○
	1st Spindle orientation		○	○	○
	Constant surface speed control		○	○	○
	M-function	M3 digit	○	○	○
	Multi-spindle control		○ (!)	○ (!)	○
Programming Functions	Rigid tapping		○	○	○
	Spindle speed override	0~150%	○	○	○
	Absolute / Incremental programming		○	○	○
	Canned cycle for drilling		○	○	○
	Custom macro		○	○	○
	Decimal point programming / pocket calculator type decimal point programming		○	○	○
	Direct drawing dimension programming		○	○	○
	Manual guide i	Conversational programming	○	○	○
	Maximum program dimension	□ 9 digits	○	○	○
	Multi repetitive canned cycle	G70~G76	○ (!)	○	○
	Optional block skip(without hardware)	Total 9 (Only NC function)	-	○	○
	Sequence number		N5	N8	N8
	Programmable data input	G10	○	○	○
	Sub program call	Nested holds	4	10	10
Tool Functions	Tape format for FANUC series 10/11		○	○	-
	Tape format for FANUC series 15		-	-	-
	Work coordinate system selection	G52~G59	○	○	○
	Auto tool offset		○	○	○
	Tool monitoring system		-	Opt.	Opt.
	Direct input of tool offset value measured B		○	○	○
	Tool geometry / wear compensation	Geometry & wear data	○	○	○
Editing Op. Functions	Tool life management		○	○	○
	Tool nose radius compensation	G40~G42	○	○	○
	T-code function	T2+2 digits	○	○	○
	Tool offset pairs		64	64	32
	Tool offset value counter input		-	○	○
	Background editing		○	○	○
Setting & Display	Expanded part program editing	Copy, Move, Change of NC program	○	○	○
	No. of Registered programs		400ea	500ea	500ea
	Part program editing / Program protect		○	○	○
	Part program storage length*1		640m	640m	640m
Data Input & Output	Display of spindle speed and T-code at all screen		○	○	○
	Help function	Alarm&Operation display	○	○	○
	Self diagnostic function		○	○	○
Other Functions	Servo setting screen / Spindle setting screen		○	○	○
	Tool path graphic display		○	Opt. (!)	○
	I/O interface	RS-232C	○	○	○
	Memory card input and output		○	○	○
Other Functions	Reader puncher control	CH1 interface	○	○	○
	Ethernet function	Embedded ethernet function	○	○	○
	MDI / DISPLAY unit		10.4" color TFT LCD	10.4" color TFT LCD	10.4" color TFT LCD
	PMC system		○	○	○

○: Standard OPT: Option (!): only M type

Fanuc 31i-A : PUMA V550-2SP  
PUMA V400-2SP

\*1 : Standard Part program length is different on export condition. On the addition of optional functions, its length can be reduced.



<http://www.doosaninfracore.com/machinetools/>

**Head Office**

Doosan Tower 20th FL., 18-12, Euljiro-6Ga, Jung-Gu, Seoul, Korea 100-730  
Tel : ++82-2-3398-8693 / 8671 / 8680 Fax : ++82-2-3398-8699

**Doosan Infracore America Corp.**

19A Chapin Rd. Pine Brook, NJ 07058, U.S.A.  
Tel : ++1-973-618-2500 Fax : ++1-973-618-2501

**Doosan Infracore Germany GmbH**

Emdener Strasse 24 D-41540 Dormagen Germany  
Tel : ++49-2133-5067-100 Fax : ++49-2133-5067-001

**Doosan Infracore Yantai Co., LTD**

13 Building, 140 Tianlin Road, Xuhui District, Shanghai, China (200233)  
Tel : ++86-21-6440-3384 (808, 805) Fax : ++86-21-6440-3389

**Doosan Machine Tools**  
*Optimal Solutions for the Future*

EN 140829SU

- The specifications and information above-mentioned may be changed without prior notice.  
- For more details, please contact Doosan.

